

Private Synchronization Technique for Heterogeneous Wireless Network (WiFi and WiMAX)

Ali Al-Sherbaz, Chris Adams & Sabah Jassim*
Applied Computing Department, University of Buckingham
UK – MK181EG

ABSTRACT

Horizontal developments in communication systems have led to the emergence of new wireless technologies like WiMAX, 3G and 4G. These expansions can provide new opportunities for further advances and exciting applications in particular if we can integrate different technology standards into heterogeneous wireless networks. WiMAX and WiFi wireless networks are two examples of different standard technologies that cannot communicate with each other using existing protocols. These two standards differ in frequency, protocol and management mechanisms, and hence to construct a heterogeneous network using WiFi and WiMAX devices these differences need to be harmonised and resolved. Synchronization is the first step towards in such a process. In this paper we propose a private synchronization technique that enables WiFi and WiMAX devices to communicate with each other. Precise time synchronization in the micro second resolution range is required. The CPU clock is used as a reference for this private synchronization. Our private synchronization solution is based on interposing an extra thin layer between MAC and PHY layers in both WiFi and WiMAX. This extra thin layer will assign alternate synchronization and other duties to the two systems.

Keyword list: Heterogeneous, WiMAX, WiFi, Convergence, Synchronization, DL-MAP, UL-MAP

1. INTRODUCTION

World Interoperability for Microwave Access (WiMAX) is the trade name of the IEEE 802.16 standard and is expected to dominate wireless networking technology for the next decade. This standard focussed on the last-mile applications of wireless technology for broadband access with mobility, high bit rate, security and long distances being its main features. The 802.16 is a set of evolving IEEE standards that are applicable to a vast array of the spectrum ranging from 2GHz to 66 GHz, which presently include both licensed and unlicensed (licence exempt) bands. The 802.16 is the enabling technology standard that is intended to provide Wireless Metropolitan Area Network (WMAN) access to locations, usually buildings, by the use of exterior illumination typically from a centralized base station (BS) as shown in fig (1). Also it has multiple subscribers referred to as subscribers station (SS) and connect back to base station via the 802.16x ([1], [2]).

WiMAX is a Point-to-Multipoint Protocol (PMP) providing equipment manufactures and operators with a standard for access profiles as well as known interoperability levels allowing for multi-vendor environments. PMP is a concept where multiple subscribers can access the same radio platform using multiplexing methods as well as queuing. The PMP Protocol used is a connection-oriented system that can take on a star or mesh configuration using FDD (Frequency Division Duplex) or TDD (Time Division Duplex). Forward Error Correction (FEC) operations are combined with Quadrature Phase Shift Keying (QPSK), 16-state Quadrature Amplitude Modulation (16QAM) and 64-state QAM (64-QAM); therefore, radio link quality is a function of coverage and interference couple with modulation format used in an allotted bandwidth and spectrum as shown in Fig (1), [2].

* {ali.al-sherbaz, chris.adams , sabah.jassim}@buckingham.ac.uk

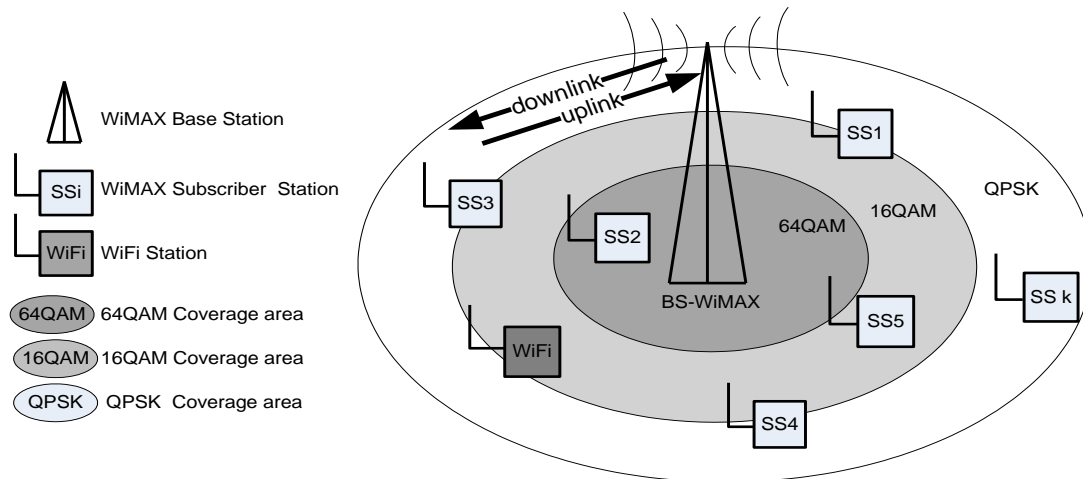

Fig (1) WiMAX Point to Multipoint (PMP) Architecture Diagram

WiFi is the previous technology of WiMAX that has been widely deployed. It is cheap, available, applicable, and has multi-vendors. It has many advantages over WiMAX, while WiMAX fills many gaps that have been found in WiFi. The WiMAX technology in its current form will complement the 802.11 or WiFi standard. The deployment and adoption of the 802.16e standard could decrease the number of WiFi users while increasing WiMAX users and WiMAX “hot spots.” The 802.16a standard will help corporations and internet service providers expand their services to the rural markets or the “last mile.”([1], [3])

This paper is concerned with WiMAX-WiFi convergence (mixed standards) as an ideal technology that provides the best of both worlds: WiMAX new features and the low cost of the WiFi. In order to create a heterogeneous network environment, differences between the two technologies have been investigated and resolved. Differences in carrier frequencies, protocols and synchronizations have been verified between the two standards. Converting the carrier frequency of the WiFi (IEEE 802.11a,b or g) to be the same as WiMAX Base station carrier frequency will be as a PHY-Layer modification while protocol matching and synchronization problem will be as a MAC-Layer modification. Bradley and Richard, [4], have explored how WiFi technologies communicate in the spread spectrum and how they differ from WiMAX. Córdova and Boets, [5], suppose that WiMAX is not going to compete with WiFi and also provided a comparison between Wireless Fidelity (WiFi) and WiMAX, and realize that the Important differences between these standards are given in the physical and medium access control layers. Jen-Ming and Chou, [6], proposed sampling clock frequency synchronization algorithm will solve the effect in time domain with symbol re-timing and the effect in frequency domain with phase tracking in the WiMAX 802.16.

IEEE 802.16 standard proposes four different PHY specifications ([7], [8]). In this paper, we will be considering the WirelessMAN-SCa PHY (2-11GHz) specification. Due to frequency band incompatibility the WirelessMAN-SC PHY (10-66 GHz) will not be considered, while the WirelessMAN-OFDM (2-11GHz) and WirelessMAN-OFDMA (2-11GHz) will be investigated in the future.

Our proposed WiMAX-WiFi convergence (mixed standards) mechanism is based on matching the two standards by interposing an extra thin layer between the MAC and PHY layer in both standards without changing the standard itself. The WiFi-side’s thin layer is in charge to follow the synchronization of the WiMAX side while the WiMAX-side’s thin layer is in charge of the protocol matching (translator). Private synchronization term has been called to define the synchronization in the WiMAX-WiFi convergence (mixed standards).

The rest of the paper is organized as follows. Section-2 illustrates WiMAX PHY layer (WirelessMAN-SCa PHY) and WiMAX MAC layer specifications. Section-3 describes, in details, the downlink and the uplink map messages for the WirelessMAN-SCa PHY specifications. Section-4 is the proposed private synchronization techniques with explanation of the extra thin layers functionalities. Section-5 is the real time implementation of the private synchronization techniques.

2. THE MAC AND PHY LAYERS FOR WIMAX

2.1 WiMAX IEEE 802.16 PHY (2-11 GHz)

Both licence spectrum and unlicensed spectrum are found in the range of (2-11 GHz), and both are discussed in details in the IEEE 802.16 standard. The overall design of the (2-11 GHz) physical layer is based on the clear demand for a non-line-of-sight (NLOS). This came about because of a realization on the part of standards developers that residence application of 802.16 would encounter multipath propagation issues because of the tree and other signal obstacles. Three air interface specifications for 802.16 are described in the original standards [2]. They are WirelessMAN-SCa, which relies on a single carrier modulation schema; WirelessMAN-OFDM, which is relies on OFDM with a 256-point transform scheme with TDMA access, which is mandatory for unlicensed bands; and WirelessMAN-OFDMA, which uses OFDMA with 2048-point transform. Here, multiple access is provided by targeting subset of various sub-carriers to individual receiving devices. In this paper, WirelessMAN-SCa physical layer has been selected for the WiMAX-WiFi convergence (mixed standards). The first stage is to convert the carrier frequency of the WiFi signal, which is either 2.4GHz or 5 GHz, via a straightforward frequency converter to be the same as WiMAX WirelessMAN-SCa Base-station carrier frequency as shown in fig (2).

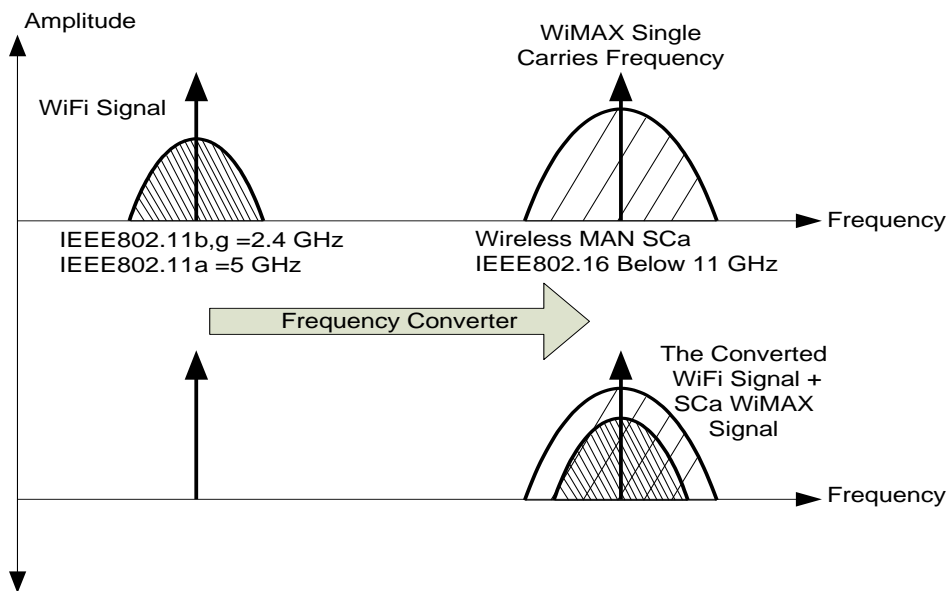

Fig (2) Frequency Conversion stage for WiFi Signal

Fig (2) illustrate the frequency domain of the WiFi signal (spectrum) which is either IEEE802.11a (5 GHz carrier frequency) or IEEE802.11b,g (2.4 GHz carrier frequency) .The WiMAX WirelessMAN-SCa signal (spectrum) has a single carrier frequency within (2-11 GHz) band, as mention in fig (2). After the frequency conversion both WiFi and WiMAX WirelessMAN-SCa signal have been carried by the same carrier frequency ([8], [9],[10]).

2.2 WiMAX IEEE 802.16 MAC

The 802.16 MAC, which support both TDD and FDD, supports a variety of transmission modalities. In TDD operation, the MAC constructs the downlink subframe, beginning with a frame control section that contains the downlink map (DL-MAP) and uplink map (UL-MAP) content. The DL-MAP message defines the usage of the downlink intervals for a burst PHY while the UL-MAP defines the uplink usage in term of the offsets of the burst relative to the allocation start time.

These maps indicate PHY transitions on the downlink and bandwidth allocations and burst profile on the uplink. The DL-MAP always applies to the current frame and is always a minimum of two FEC (Forward Error Correction) blocks long. The UL-MAP facilitates allocations that begin its allocation process in the current frame as long as processing times and round-trip delay limitation are met. Fig (3) explains a TDD, which is transmitting the downlink and the uplink in different time and usually shared the same frequency. TDD frame has one downlink and one uplink subframes with fix frame duration. The TDD frame constructs from k-integer unit time called physical slots (PS). While $k = (\text{symbol rate} \times \text{frame duration}) / 4$, e.g. symbol rate = 512 KS/s and frame duration = 2 ms then number of physical slot, $k = 256$ PS. These PSs helps to divide the bandwidth allocation easily. Bandwidth allocations for downlink versus the uplink is adaptive, therefore, higher system layers have the ability to control the edge offset (ATDD) between uplink and downlink as shown in fig (4) [3].

The downlink subframe is the reference of the time synchronization, therefore; the Allocation Start time of the UL-MAP referred from the downlink subframe. The UL-MAP refers to a point in either to a current subframe or a future subframe. As shown in fig(4), the downlink subframe begins with a frame control header (FCH) that includes the DL-MAP for the current downlink frame as well as the UL-MAP for some specific future period.

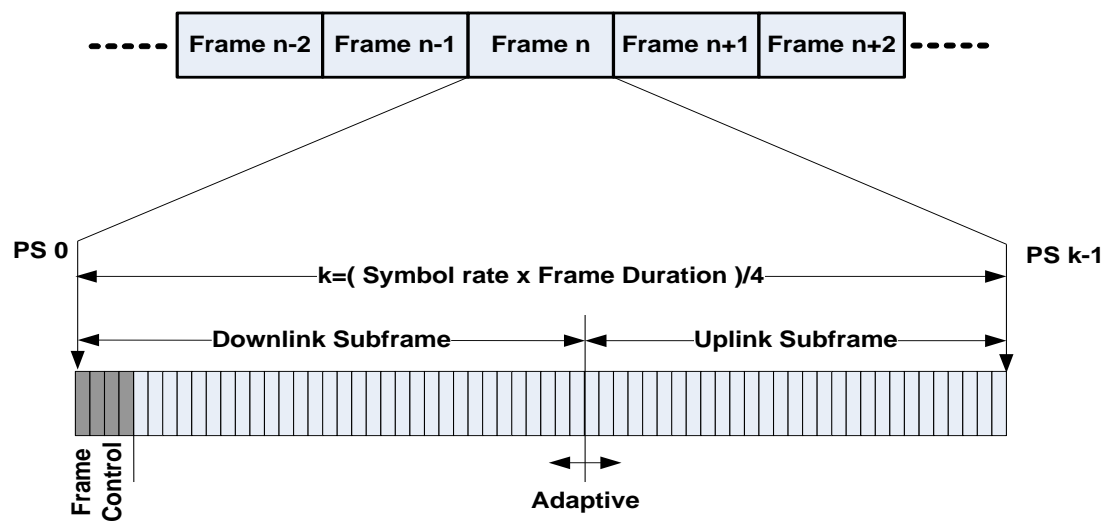

Fig (3) TDD frame Structure

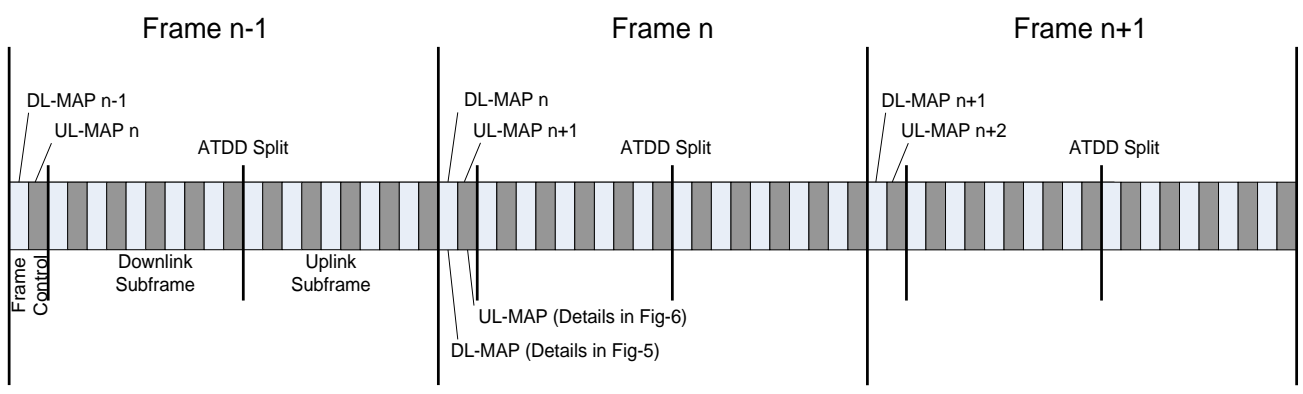

Fig (4) Time relevance of DL-MAP and UL-MAP (TDD)

The DL-MAP specified when modulation and FEC changes occur in downlink subframe. Typically, the downlink subframe includes a TDM-specification portion immediately after the frame control section. Data on the downlink are transmitted to each subscriber station (SS) by relying on negotiated burst profile. The data are transmitted in decreasing robustness to permit the station to receive the data correctly and minimizing the possibility of receiving a burst profile that could cause the station to lose downlink synchronization. Because of diverse application requirements, the breath and duration of burst profiles may vary widely from frame to frame. Fig (5) describes the DL-MAP message in details for the WirelessMAN-SCa physical layer while fig (6) describe the UL-MAP message in details for the WirelessMAN-SCa physical layer ([3],).

3. DL-MAP AND UL-MAP MESSAGES

IEEE 802.16 has standard uniform management and control messages. DL-MAP and UL-MAP are categorized as MAC management messages. These messages shall be carried in the MAC frame. In order to distinguish between the messages, all management messages start with 8-bit field represent the type of the messages regardless of the PHY specification. 802.16 standard pre-define the management type e.g. DL-MAP message's Type =2, while UL-MAP message's Type= 3 and both are defined as a broadcast messages [3].

3.1 DL-MAP for WirelessMAN-SCa PHY specification

The Base station broadcasts the DL-MAP management message during the frame control header in the downlink subframe intervals. Fig (5) explains the DL-MAP message format for the WirelessMAN-SCa PHY; the PHY synchronization field is 24-bit for the WirelessMAN-SCa PHY, because this field is variable as appropriate PHY specifications. The DCD-count field (8-bit) is part from the DCD (Downlink Channel Descriptor is one of the broadcast management messages with Type=1). DCD-count field is incremented by one (mod 256) by the BS whenever any value of other DCD fields change. If the value of DCD-count remains the same, the SS can quickly decide that the remaining fields have not changed and may be able to disregard the reminder of the message. Base Station ID is a 48 bit long field identifying the BS and shall be programmable.

The DL-MAP_IE() is the DL-MAP information element for a specific subscriber station and the number of DL-MAP_IE() is variable from frame to frame. DL-MAP_IE() is like a timetable for the SSs downlink scheduling. For example, if there are 15 subscriber stations, five of these SSs have been selected for this download subframe. Five sequential DL-MAP_IE()s will be created by the BS to represent the time schedule for these five SSs for one downlink subframe interval. After the DL-MAP broadcasting message has been received, each one of these five SSs know exactly when will start its downlink interval in the current frame (Offset= how far PS from the beginning of the frame).

The DL-MAP_IE() format for the WirelessMAN-SCa physical specification is 36-bits (fig-5). Downlink interval usage code (DIUC 4-bits) is a code identifying a particular burst profile that can be used by a downlink transmission interval. Next filed is the Offset (in a units of PS is 16-bits), which is the number of PS to the start of the data burst from the start of the current frame. Connection Identifier (CID) is a 16-bits value that identifies a connection to equivalent peers in MAC of the BS and SS [3].

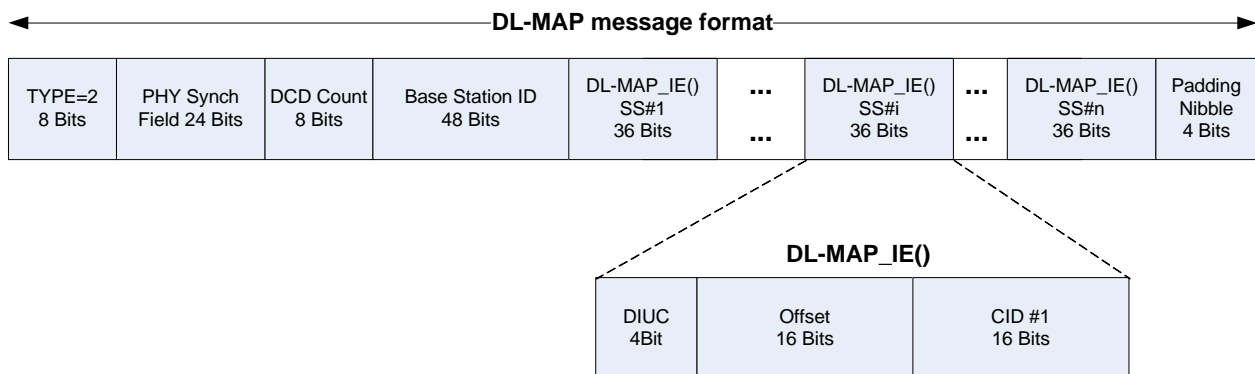

Fig (5) DL-MAP message format WiMAX SCa-PHY

3.2 UL-MAP for WirelessMAN-SCa PHY specification

The Base station broadcasts the UL-MAP management message during the frame control header in the downlink subframe intervals as shown in fig (4). Fig (6) explains the UL-MAP format for the WirelessMAN-SCa PHY specification. As mention above the type of the management message for the UL-MAP is Type=3. The Uplink Channel ID field (8-bits) is the identifier of the uplink channel to which this message refers. The UCD-count field (8-bit) is part from the UCD (Uplink Channel Descriptor is one of the broadcast management messages with Type=0). UCD-count field is incremented by one (mod 256) by the BS whenever any value of other UCD fields change. If the value of UCD-count remains the same, the SS can quickly decide that the remaining fields have not changed and may be able to disregard the remainder of the message. Allocation Start Time (32 bits) is the effective start time of the uplink allocation defined by the UL-MAP. The unit of the Allocation Start Time will be the number of physical slot PSs from the start of the downlink frame in which the UL-MAP message occurred. The minimum value for this parameter shall corresponds to one frame duration.

The UL-MAP_IE() is the UL-MAP Information Element for a specific subscriber station and the number of UL-MAP_IE() is variable from frame to frame. UL-MAP_IE() is like a timetable for the SSs uplink scheduling. Return back to above example; if there are 15 subscriber stations, five of these SSs have been selected for uplink subframe. Five sequential UL-MAP_IE()s will be created by the BS to represent the time schedule for these five SSs for one uplink subframe interval. After the UL-MAP broadcasting message has been received, each one of these five SSs know exactly when will start its uplink interval in the current or a future frame.

The UL-MAP_IE() format for the WirelessMAN-SCa physical specification is 52-bits (fig-6). CID (8-bits) Uplink Channel ID represents the assignment IE (information element) to a unicast, multicast, or broadcast address. When specifically addressed to allocate a bandwidth grant, the CID shall be the Basic CID of the SS. Uplink interval usage code (UIUC 4-bits) used to define the type pf uplink access and trust type associated with that access. A burst descriptor shall be included in an UCD message for each UIUC that is to be used in the UL-MAP. The Offset field (12-bits) is indication of the start time, in units of PS, of the burst relative to Allocation Start Time given in the UL-MAP message. Consequently, the first IE shall have an offset of 0. The end of the last allocated burst is indicated by allocating an End of the map burst. The time instants indicated by offsets are the transmission times of the first symbol of the burst including preamble. The Duration field (12-bits) is for bursts associated with one of the spread BPSK modulation types or the subchannel burst set type, this parameter specifies the length of the associated burst in PSs. Starting subchannel field (4-bits) is for bursts associated with subchannel burst frame type, this parameter specifies starting IE channel assigned to the transmission. The Subchannel count field (4-bits) is for burst associated with the subchannel burst set type, this parameter specifies the number of adjacent subchannels assigned to the transmission [3].

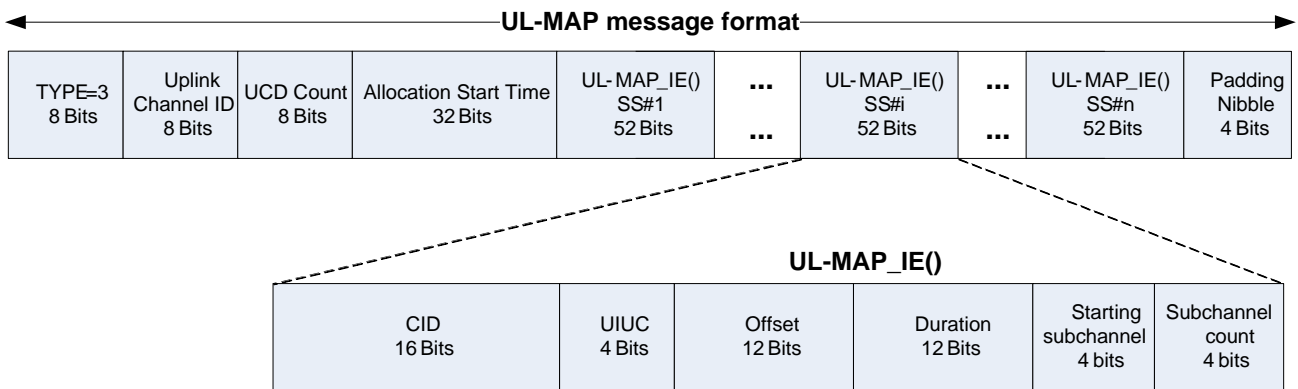

Fig (6) UL-MAP message format for WiMAX SCa-PHY

4. THE PROPOSED PRIVATE SYNCHRONIZATION TECHNIQUE

WiMAX-WiFi convergence (mixed-standard) needs some preparatory steps. Both wireless standards have been investigated in order to classify the differences. Dissimilarities between wireless standards are usually in the lower layers so that the investigations are focused on the PHY and MAC layers. Frequency, synchronization and protocol matching are the main area for these differences. Each wireless standard has two or more PHY specification. Several WiFi PHY specifications could be involved in this convergence while only one WiMAX PHY specification can be involved. Due to the nature of the WiMAX standards in producing new wireless features, four diverse PHY specifications have been approved in the IEEE 802.16. These diverse PHY specifications will generate different MAC level management messages, so that choosing a specific WiMAX-PHY is vital. As mention above, IEEE 802.16 standard proposes four different PHY specifications; WirelessMAN-SCa PHY (2-11GHz) specification has been selected for this paper whilst WirelessMAN-SC PHY (10-66 GHz) have not been selected due to frequency band incompatibility. The others two 802.16 PHY specifications WirelessMAN-OFDM (2-11GHz) and WirelessMAN-OFDMA (2-11GHz) will be investigated in future work.

4.1 Unified the Frequency Bands

The first dissimilarity between both standards is the frequency bands. If these frequency bands had been unified, the first problem (dissimilar frequency bands) will disappear. As mention in section 2.1, the frequency conversion stage for WiFi Signal (carrier frequency) has been illustrated in fig (2). WiMAX Base Station (BS) and the Subscribers' Stations (SS) work in the same carrier frequency, therefore; WiFi signal (carrier frequency) should be converted to the same WiMAX carrier frequency. The WiFi carrier frequencies for the IEEE 802.11b,g is 2.4 GHz and IEEE 802.11a is 5 GHz. Both WiFi signals could be converted from their carrier frequency to the WiMAX carrier frequency (2.5 GHz, 3.5 GHz, 5 GHz or 6 GHz). The Frequency conversion stage is a pure PHY layer operation that is a simple RF conversion from band to band. Whilst the first problem has been solved, the WiMAX-WiFi convergence does not work yet because, actually, the synchronization and protocol matching problems are much more complicated.

4.2 Synchronized WiFi with WiMAX

Wireless (WiFi, WiMAX) standards investigations have been focused on the timing mechanisms for both wireless technologies. Obviously, these mechanisms have dissimilarities in timing and synchronization. For the PMP WiMAX topology, the base station (BS) is responsible for the timing management and the SSs should be synchronised with it. To synchronize the WiFi signal within the WiMAX environment needs a little change in the WiFi time synchronization. As shown in fig (7), our proposal is to add an extra thin layer to the WiFi side, which is responsible to synchronize to WiFi side and to follow the WiMAX Base Station timing.

In the WiFi side an extra thin layer has been interposed between the PHY and MAC layers. In particular, the functionalities for this thin layer are:

- *Pre-Knowledge*: A knowledge base has been created for this thin layer. This knowledge base is definitions of the IEEE 802.16 standard management messages format. This knowledge base will be useful to enable the thin layer to recognize these management messages. e.g. for the WirelessMAN-SCa PHY specification the DL-MAP and the UL-MAP messages format have been illustrated in fig (5) & fig (6).
- *Controller*: This thin layer is, exactly, a device driver having the ability to control the WiFi device driver externally. In reality, this thin layer has disabled the main WiFi send/receive timing and controlled the send/receive timing by itself. This controller (thin layer) has been built without any change in the main WiFi device driver core.
- *Listener*: It has the ability to listen to the incoming WiMAX messages and recognize these messages depending on its knowledge base definitions. Eventually, developing the WiFi device to have the capability to read (recognize) these messages has opened the gate for WiMAX-WiFi convergence.

- *Synchronization:* Regarding the WiMAX DL-MAP and UL-MAP messages, the WiFi device will have the ability to send/receive in its part of the time frame (WiFi Burst) within the WiMAX environment and will not send/receive in any other part of the time frame. A precise time synchronization has been demanded which requires micro second resolution. The thin layer timing will depend on the CPU clock, which is used as a reference for this private synchronization.
- *Calculate The WiFi Bursts:* The BS decides all SSs' bursts. These have been broadcasted as DL-MAP and UL-MAP messages. These maps contain full details of the SSs downlink and uplink burst times. As shown in fig (5) & fig (6), the DL-MAP_IE() and UL-MAP_IE() have the offset field which is the number of Physical Slots (PS) from the start of the current frame to the start of the data burst.

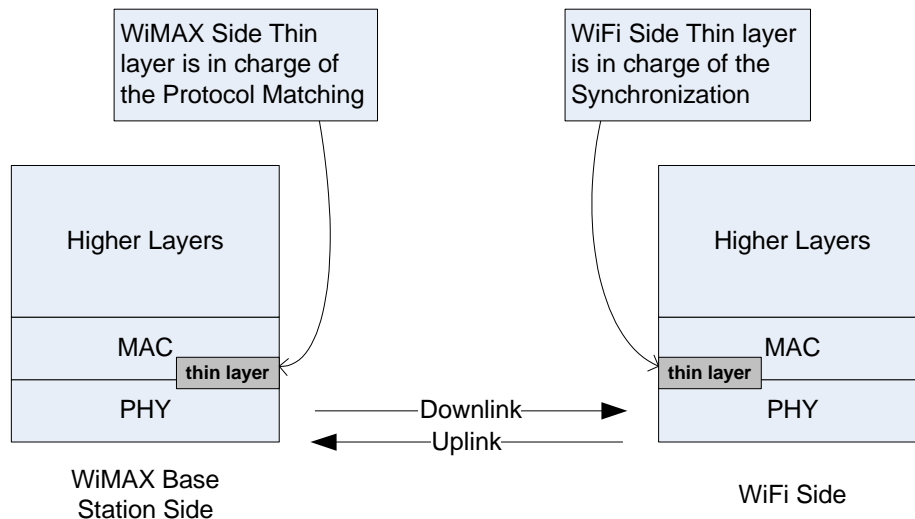

Fig (7) The proposed Extra Thin layers for WiMAX and WiFi

4.3 Protocol Matching

The third problem, which has been investigated, is the protocol-matching problem. This described how to harmonized the differences between WiFi and WiMAX messages formats. Our proposal to solve this problem, similar to the WiFi side, is by interposing an extra thin layer which is responsible to encapsulate the WiFi transmit messages and decapsulate the WiFi receive messages in the WiMAX-MAC layer in order to harmonize the protocol matching problem as shown in fig (7).

In the WiMAX side an extra thin layer will be interposed between PHY and MAC layers, this thin layer has different functionalities from the WiFi extra thin layer. Particularly, WiMAX extra thin layer has the following functions:

Pre-knowledge: As same as the WiFi extra thin layer, a knowledge base has been created for this thin layer. This knowledge base is definitions of the IEEE 802.11 standard management messages formats. This knowledge base will be valuable in allowing the thin layer to encapsulate/decapsulate the transmit/receive WiFi messages.

Listener: It has the ability to listen to the DL-MAP and UL-MAP messages and thus construct a precise time map of the WiFi transmit/receive processes.

Translator: This function is the core of the protocol matching process. It is in charge to decapsulate/encapsulate the transmitting /receiving WiFi messages to/from the WiMAX higher layers.

4.4 Real time Implementation

Real time implementation of private synchronization technique has been tested under Linux platform (Kernel 2.6). This open source environment provides free exploring inside the main wireless network device driver. The device driver is combination of modules that have been developed using C-Code. These modules correspond to different tasks for the wireless network device [11]. Multitasks managements between CPU, Linux-Kernel, Higher Layers and Wireless network device have been doing by the wireless network device driver. The wireless network device driver covers the job of Network-layer, MAC-layer and Part of PHY-layer in the OSI network model [12].

For the following wireless device tasks classifications, the device driver has covered the MAC and the combine (Hybrid) tasks while the PHY-tasks have not been covered.

Tasks Classifications ([13], [14]):

I. PHY-Layer Tasks: the hardware parts of the wireless network devices are: -

- Radio Frequency (Antenna, RF-Amplifier, Frequency Synthesiser, Signal Strength etc...)
- Modulation/Demodulation (QPSK, 16QAM, 64QAM, OFDM etc...)
- Encoding /Decoding
- Bus interface: PCI, USB or PCMCIA

II. MAC-Layer Tasks: the software parts of the wireless network devices are: -

- Initialization /Registration
- Association / Re-association
- Transmitting (Tx)/ Receiving (Rx)
- Encapsulation / Decapsulation
- Interrupt handling

III. Hybrid (PHY-MAC) Tasks: Combinations of hardware and software parts of the wireless network device are:

- Network Device Data Structure
- FLAGS: TIMEOUT, JIFFIES, CPU-REGISTERS (64 bits) etc...
- Kernel Device Driver
- PHY –Layers Setting

Interposing an extra thin layer in the above incorporated system is a difficult undertaking. The implementation covers the extra thin layer functions, which have been described in the previous sections. The thin layer had disabled the timing of the Transmit/Receive functions and had controlled this timing by itself. According to the hybrid tasks, the CPU-REGISTER (64 bits) had been using as timing reference for the synchronizations while the Network Device Data Structure had been used for listening and controlling. Listening to the periodic FCH messages (DL-MAP and UL-MAP) from the BS is the key for synchronization.

As shown in fig (5) DL-MAP message format, PHY-Synch fields (24 bit) would be used for synchronization. The thin layer is dedicated to establish the synchronization with the PHY-SYNCH field; this field will be sent periodically with fixed period of time (i.e. Frame Duration). This thin layer synchronization enabled the reading of the DL-MAP and UL-MAP messages. From the DL-MAP message, the WiFi thin layer looks for the related DL-MAP_IE() with the offset field which is the number of Physical Slots (PS) from the start of the current frame to the start of the WiFi downlink burst time. From the UL-MAP message, more less the same, the WiFi thin layer looks for the UL-MAP_IE() with the offset field to start the WiFi uplink burst time .

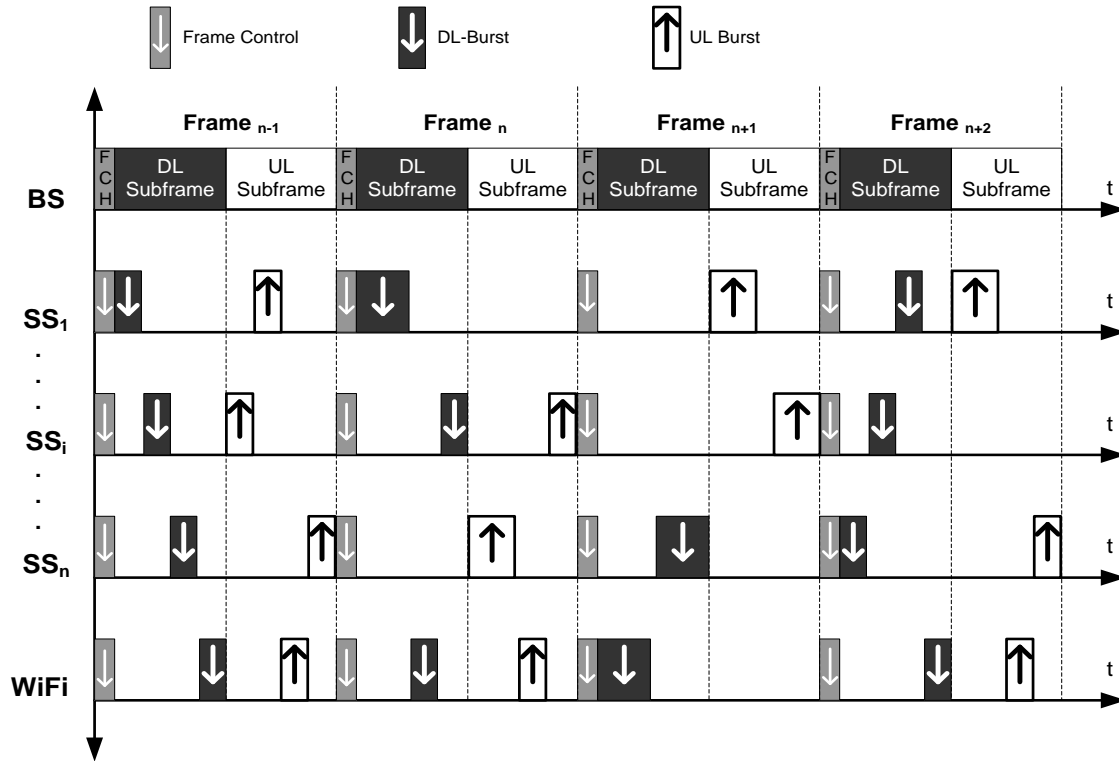

Fig (8) Downlink, Uplink and Frame Control Header (FCH) Timing Diagram for WiMAX-SCa (TDD) plus WiFi device

The aim of the private synchronization technique is to enable WiFi and WiMAX devices to communicate with each other. Interposing these thin layers solves the problem of intercommunication and enables WiFi-WiMAX convergence. Fig (8) illustrates, using timing diagram, a WiMAX environment (BS with SSs) with a single WiFi device. For the WiMAX-SCa, the TDD-frame divides into two parts the downlink time part and uplink time part. The downlink time part divides into Frame Control Header (FCH) and downlink subframe (DL-Bursts) while the uplink time part is only the uplink subframe (UL-Bursts).

In Frame_{n-1}, fig (8), the BS broadcasts the FCH (DL-MAP + UL-MAP) periodically, therefore; all SSs and the WiFi have obtained the DL-MAP for the current frame and the UL-MAP for the current or future frames. More details of the frame structures are shown in figs (3,4). The SSs and WiFi on receipt to of the DL-MAP and UL-MAP are ready to calculate their downlink and uplink burst times (duties) depending on the offsets. More details are shown in 3.1 and 3.2. In the downlink subframe time, fig (8), SS₁ gets the first burst data then the bursts to SS_i..SS_n and followed by the last burst data which is for the WiFi station. In the uplink subframe time the data bursts sequence is SS_i, SS₁, WiFi then SS_n. These bursts have been planed by the Base-Station. **In Frame_n**, a different map has been broadcasted, for the downlink subframe time, SS₁ gets the first burst data with more bandwidth than a previous bandwidth request, while SS_n has not had a chance to receive in this downlink subframe due to contention. In the uplink subframe time, SS₁ has not had a chance in this uplink subframe, while WiFi gets a chance for both downlink and uplink subframes. Obviously, the extra thin layer has enabled the WiFi to calculate the burst times in order to transmit/receive at the right time and to be synchronized with the WiMAX environment. **In Frame_{n+1}**, another scenario is shown, WiFi gets more bandwidth than its previous request for this downlink subframe, while it has not had a chance to transmit in this uplink subframe. **In Frame_{n+2}**, WiFi received the broadcast map as usual and calculates the WiFi burst position from DL-MAP and UL-MAP contained in the FCH. The thin layer is able to calculate the offsets in real time as indicated in 4.2. The FCH is a fixed time periodic message (Frame Duration – fig (3)) with precise timing derived by the BS. The CPU-REGISTER (64 bits) is used as a subframe timing reference to synchronize microsecond timing within the frame duration, which is in millisecond. Periodically every second, CPU timing drift is checked and recalculated to prevent long term drift errors.

5. CONCLUSION AND FUTURE WORKS

The effort of this paper is producing a WiMAX-WiFi convergence (mixed-standard), which is an ideal technology that provides the best of both worlds: WiMAX new features and the low cost of the WiFi. In order to create a heterogeneous network environment, differences between the two technologies have been investigated and resolved. Differences in carrier frequencies, protocols and synchronizations have been verified between the two standards. Our proposal is based on matching the two standards by interposing an extra thin layer between the MAC and PHY layer in both standards without changing the standard itself. The WiFi-side's thin layer is in charge of following the synchronization with the WiMAX side whilst the WiMAX-side's thin layer is in charge of the protocol matching. Private synchronization techniques have been used to provide microsecond burst positioning within the overall time frame and thus providing the bases of WiMAX-WiFi convergence (mixed standards). The IEEE 802.16 standard proposes four different PHY specifications. In this paper, we considered the WirelessMAN-SCa PHY (2-11GHz) specification. Due to frequency band incompatibility the WirelessMAN-SC PHY (10-66 GHz) will not be considered, while the WirelessMAN-OFDM (2-11GHz) and WirelessMAN-OFDMA (2-11GHz) will be investigated in the future work.

REFERENCES

- [1] Steven Shepard ,[WiMAX Crash Course], McGraw Hill, New York , (2006)
- [2] Clint Smith, John Meyer ,[3G Wireless with WiMAX and WiFi], McGRAW-HALL, New york ,(2004)
- [3] 802.16-2004," Part16: Air Interface for Fixed Broadband Wireless Access System", IEEE Standard for Local Metropolitan Area Network,(2004)
- [4] Bradley K. Patton, Dr. Richard Aukerman and Dr. Jack D. "Shorter wireless technologies, wireless fidelity (WiFi) & worldwide interoperability for microwave access (WiMAX)", Issues in Information Systems Volume VI No. 2, (2005)
- [5] H. Córdova , P. Boets L. Van Biesen , "Insight Analysis into WI-MAX Standard and its trends", International Workshop on Wireless Ad-hoc Networks in London ,(2005)
- [6] Jen-Ming Wu , Chun-Hung Chou ,"Baseband Sampling Clock Frequency Synchronization for WiMAX Systems", Institute of Communications Engineering National Tsing Hua University Hsinchu, Taiwan, (2005)
- [7] Matthew S. Gast ,[802.11 Wireless Networks] , O'REILLY ,Cambridge,(2002)
- [8] Glen Carty ,[Broadband Networking], Mc Graw Hill/OSBORNE, (2002)
- [9] JOCHEN SCHILLER ,[Mobile Communications] 2nd Edition, ADDISON WESLEY,London Boston, (2003)
- [10] William Stallings ,[Wireless Communication and Networks], Prentice Hall,New Jersey, (2002)
- [11] Andrew S. Tanenbaum , Albert S. Woodhull ,[Operating Systems Design and Implementation] third Edition , PEARSON Prentice Hall,New Jersey, (2006)
- [12] JONATHAN CORBET, ALESSANDRO RUBINI AND GREG KROAH-HARTMAN, [Linux Device Drivers] 3rd Edition, O'REILY, Cambridge, (2005)
- [13] Penny Orwick, Guy Smith, [Developing Drivers with the Windows Driver Foundation], Microsoft Press, (2007)
- [14] Daniel P. Bovet and Marco Cesati, [Understanding the LINUX KERNEL], O'REILLY, Cambridge,(2001)